

Simple
Safe
Smart

BALLAST WATER TREATMENT SYSTEM

GloEn-Patrol™



HEAD OFFICE & FACTORY

618-220, 55, Mieumsandan 3-ro, Gangseo-gu, Busan, Korea
TEL: +82-51-831-1010 | FAX: +82-51-831-1399
www.worldpanasia.com | E-mail: panasia@worldpanasia.com

MARKETING

TEL: +82-70-4875-7039 | E-mail: marketing@worldpanasia.com

R&D

TEL: +82-70-4875-7088 | E-mail: rnd@worldpanasia.com

DESIGN

BWTS TEL: +82-70-4875-7071 | E-mail: design@worldpanasia.com
TLGS TEL: +82-70-4875-7079 | E-mail: design21@worldpanasia.com

SERVICE

BWTS TEL: +82-70-4875-7147 | E-mail: bwts_service@worldpanasia.com
TLGS TEL: +82-70-4875-7145 | E-mail: tlgs_service@worldpanasia.com



PANASIA CO.,LTD.

Global Leader in Smart & Green Technology

- Since 1989

CONTENTS

- 3 Company Profiles
- 4 GloEn-Patrol™
- 8 GloEn-Patrol™ Component
 - Filter unit
 - UV unit
 - Panels
- 13 PSRS – Pit Stop Retrofit Service
- 16 Reference
- 19 Worldwide Service Network



Established Date

Oct. 10th, 1989

Product List

- Ballast water treatment system
- DeNOx SCR system
- SOx Scrubber system
- Cargo monitoring system
- Tank level gauging system
- Sensors (Pressure, Temperature)

Achievement in GloEn-Patrol™

| | | | | | |
|------------|---|---|------------|---|--|
| 2015. Jan. |  | Grand prize of technical commercialization from Research & development special zone | 2012. Dec. |  | Korean world-class product |
| 2014. Jun. |  | World Class 300 | 2011. Aug. |  | IR 52 Jang Young Sil award* (32week's) * The award given weekly in the name of the Minister of Science and Technology is so widely recognized to be one of the highest for innovation in Korea that even the general public can approve the value of the award. |
| 2013. Dec. |  | Gold tower order of industrial service merit at 2013 Korea Technology | 2010. Dec. |  | Bronze award at 2010 Korea Technology Awards |

GloEn-Patrol™

Ballast Water Treatment System

- Filtration & UV Irradiation



▲ Test barge

With experiences specializing in shipbuilding industries and skilled people understanding the characteristics of shipping industries, PANASIA came up and provided the **easiest, safest, and simplest solution for ballast water treatment system** based on effective filtration and UV irradiation since 2010 when acquired its type approvals. This technology has been proved and widely used to disinfect the harmful organisms in the ballast water without producing any toxic substance.

This simple configuration of GloEn-Patrol™ is combined the filtration unit with 50µm filter element which provides the most effective and efficient back flushing function than any other conventional filters can do and medium pressured UV lamps which give customers assurance to last long life to treat and disinfect the ballast water in ballasting and de-ballasting stage. In addition, this uniquely engineered and designed filter and UV lamp are manufactured by PANASIA's own technologies to provide the upmost quality, reasonable price and on time delivery to the customers.

The system flow has four types. In order to acquire an appropriate dose of UV lamps, system uses warming up mode in which sea water passes filter & UV but not flow into ballast tank. When system sets up, ballasting mode starts. In the mode, the ballast water from sea chest enters through the inlet pipe into the filter and flows through the cylindrical filter element from inside out. Organisms larger than 50µm are eliminated and those smaller than 50µm will pass into UV unit for disinfection. During filtration, sediments are accumulated on the surface of filter element and it is flushed out to overboard by the back-flushing function without any disturbance on filter operation. During de-ballasting mode, the ballast water from the ballast tanks passes through the UV unit to prevent reproduction of organisms and flows out to overboard. During Bypass mode, the ballast water skips filter and UV unit and simply flows out to overboard.

FEATURES

- Effective disinfection of harmful aquatic organism
- Component concept for stabilized capacity expansion
- Less power consumption
- Low maintenance cost
- Simple operating system
- Automatic back flushing in the filtration unit
- Automatic Wiper cleaning in the UV unit
- Easy installation - skid / vertical, horizontal arrangement, separate components
- Irrespective of water condition such as water salinity, temperature
- No requirement of dosing liquid or powder chemicals for disinfection
- Not producing active substance

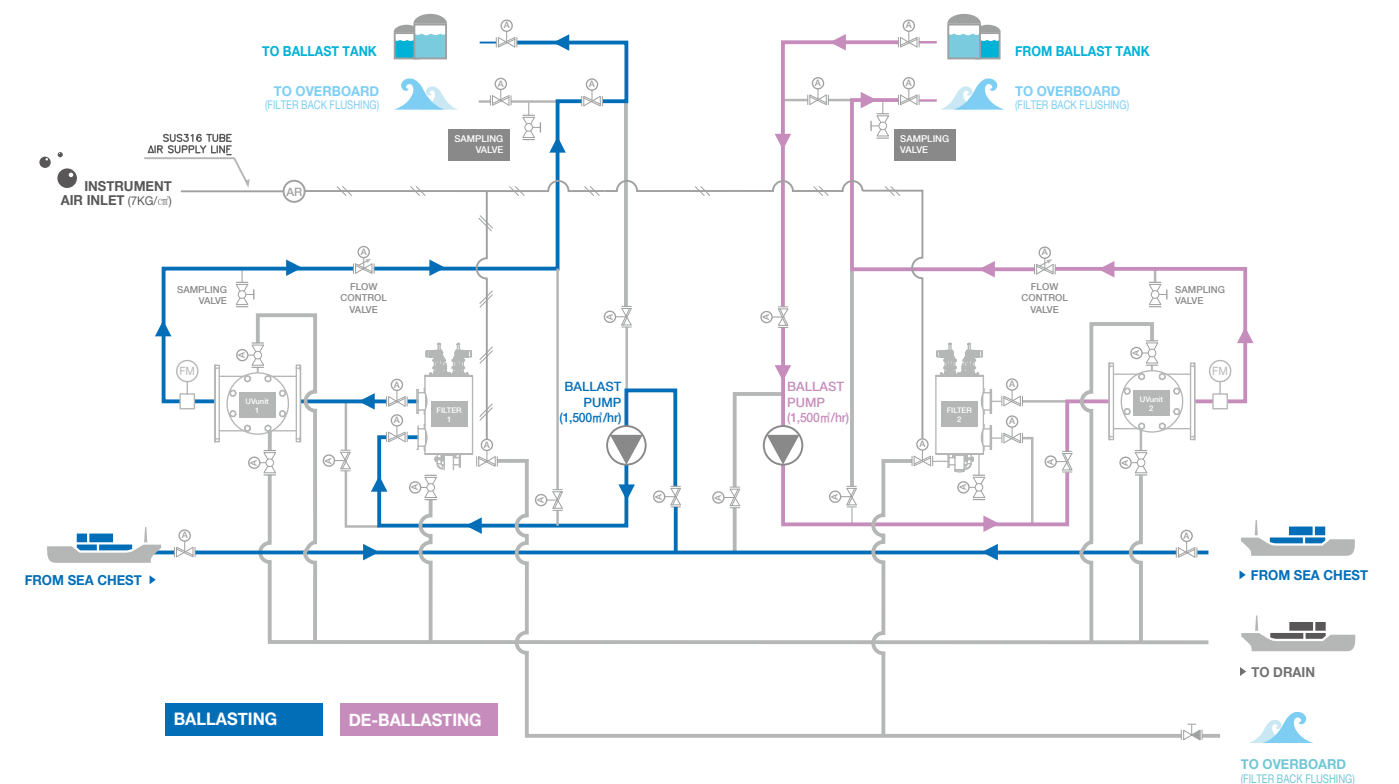

FLOW DIAGRAM (GloEn-P1500)



GloEn-Patrol™

Simple, Safe and Smart

PRODUCT LINE UP

| | GloEn-Patrol™ G I | GloEn-Patrol™ G II | GloEn-Patrol™ G III |
|--------------------|---|---|---|
| |  |  |  |
| Component | Original Filter Unit Original UV Unit | MEGA Filter Unit Original UV Unit | MEGA Filter Unit MEGA UV Unit |
| Treatment Capacity | 50 ~ 750m³/h | 800 ~ 3,000m³/h | 800 ~ 3,000m³/h |
| Feature | Small capacity in single unit | Less footprint & Power consumption in large capacity | Large capacity in single unit with high efficiency |

CERTIFICATES



INSTALLATION COMPARISON BETWEEN GI AND GIII MODEL



Treatment capacity
3,000m³/hr

Improved
In space & Power Consumption



Treatment capacity 3,000m³/hr

High Efficiency _ **40%** of power consumption is reduced.

| Model | Treatment Capacity | Power Consumption | | Reduced by |
|-------|--------------------|-------------------|--------------------------------|------------|
| | | GloEn-Patrol™ I | GloEn-Patrol™ III Min. Max. | |
| P1000 | 1,000m³/hr | 120kW | 56kW 77kW | 36% |
| P1200 | 1,200m³/hr | 160kW | 65kW 90kW | 44% |
| P1500 | 1,500m³/hr | 174kW | 80kW 110kW | 37% |
| P2000 | 2,000m³/hr | 240kW | 113kW 155kW | 35% |
| P2500 | 2,500m³/hr | 320kW | 131kW 180kW | 44% |
| P3000 | 3,000m³/hr | 360kW | 164kW 225kW | 38% |



Power Consumption
40%

Minimized Footprint _ **44.5%** of installation area is reduced.

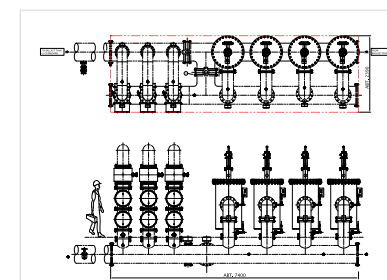

GloEn-Patrol™ G I
2.39m X 7.4m = **17.7m²**

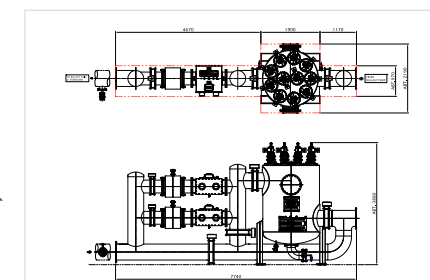

GloEn-Patrol™ G III
2.19m X 1.9m + 0.97(1.17+4.67) = **9.83m²**



Minimized Footprint
44.5%

Simple Configuration Filter Unit



SCREEN TYPE FILTER

The ballast water enters into the filter and flows through the cylindrical filter element from inside out. The filtration cake accumulating on the filter element surface causes pressure difference to develop across the filter element. The back-flushing begins when the pre-set pressure difference between inlet and outlet on the filter is reached or pre-determined lapse of time is met. During the back-flushing cycle, the filtering is not interrupted and continues to flow downstream of the filter in the normal manner.

Regardless of this outstanding technology, Original Filter has met challenges when pump capacity gets bigger, the number of filter units increase simultaneously, requiring more footprint reluctantly. As a solution to this concern, we've developed MEGA Filter Unit to appropriately apply for bigger capacity (from 900 m³/hr up to 3,000 m³/hr), providing multi-cylindrical filter elements to maximize the performance for the filter unit with less footprint (approx. 44.5%) compared to Original Filter.

COMPONENT LINE-UP

| | Model | Treatment Capacity |
|----------------------|---------|-------------------------|
| Original Filter Unit | PF 250 | 250 m ³ /h |
| | PF 500 | 500 m ³ /h |
| | PF 750 | 750 m ³ /h |
| MEGA Filter Unit | PF 900 | 900 m ³ /h |
| | PF 1200 | 1,200 m ³ /h |
| | PF 1500 | 1,500 m ³ /h |
| | PF 2000 | 2,000 m ³ /h |
| | PF 2500 | 2,500 m ³ /h |
| | PF 3000 | 3,000 m ³ /h |



| Type | Single screen type | Type | Multi cage screen type |
|-------------------------|-----------------------------------|-------------------------|-----------------------------------|
| Capacity | 250 ~ 750 m ³ /hr | Capacity | 900 ~ 3,000 m ³ /hr |
| Max. Operating Pressure | 10 bar | Max. Operating Pressure | 10 bar |
| Grade of filtration | 50 μm | Grade of filtration | 50 μm |
| Filter Element Material | SUS 316L / Hastelloy | Filter Element Material | SUS 316L / Hastelloy |
| Backflushing control | Differential Pressure - dependent | Backflushing control | Differential Pressure - dependent |

Simple Configuration UV Unit



For the BWTS based on the filtration and UV technology, the other important part for an assurance of its operation is to guarantee the performance of UV lamps. GloEn-Patrol™ uses the UV lamps which are especially engineered, designed and manufactured by PANASIA in ballast water disinfection purpose. The intensity of UV lamp is automatically adjusted by three levels according to flow rate, and transmittance to assure stable UV lamp performance. GloEn-Patrol™ uses medium pressure UV lamps that output a variety of wavelength and enables to treat more various micro-organisms compared to any other UV lamps. To maintain the cleaned quartz sleeve condition, automatic wiping function is adopted that cleans the quartz sleeve by

wiper's back and forth movement. Although this excellent performance is guaranteed, there's no harmful and toxic chemicals neither required nor produced for running our system. Basically it is 100% safe treatment method.

With the attitude of listening customer's thoughtful comments, we have developed, a brand new MEGA UV Unit, treating even bigger capacity with less footprint by reducing the power consumption of approx. 40% compared with Original UV unit so that GloEn-Patrol™ can be confidently supplied for bigger vessels.

COMPONENT LINE-UP

| | Model | Treatment Capacity | |
|------------------|---------|------------------------|------------------------|
| Original UV Unit | PU 250 | 150m ³ /hr | |
| | | 250m ³ /hr | |
| | | 350m ³ /hr | |
| | PU 500 | 500m ³ /h | |
| | | 700 m ³ /hr | |
| MEGA UV Unit | PU 1000 | 1,000m ³ /h | |
| | | PU 1250 | 1,250m ³ /h |
| | | PU 1500 | 1,500m ³ /h |

| Original UV Unit | MEGA UV Unit |
|------------------|--------------|
|------------------|--------------|



| | | | |
|-------------------------------|-----------------------------|-------------------------------|---------------------------------|
| Capacity | 150 ~ 700m ³ /hr | Capacity | 1,000 ~ 1,500m ³ /hr |
| Max.Operating Pressure | 10 bar | Max.Operating Pressure | 10 bar |
| Automatic cleaning wiper | | Automatic cleaning wiper | |
| Explosion Proof Type (option) | | Explosion Proof Type (option) | |

Simple Configuration Panels



Pit Stop Retrofit Service

CONTROL PANEL

UV POWER SUPPLY PANEL



The monitor & control panel is PLC based and configured to activate and deactivate UV lamps via UV power supply panels in order to maintain the sufficient UV dose while conserving power. The monitor & control panel offers a real time monitoring of the status of system operation while logging the data required by the convention at the same time.

The major function of Power Supply Panel is to operate the medium pressure UV lamps UV. It controls the strength of UV lamps with the capacitors mounted in the Panel. Also it detects whether the UV lamps are functioning properly or not. The temperature sensor is mounted inside to monitor temperature in order to give an alarm to an operator and shut down the system in case of overheating.

- Smart HMI system
- Data logging for 24 months
- Main data real time display (Position, Pressure, Flow, Temperature, etc)
- Alarm function (Interface with AMS or Load master)
- Controller: Siemens PLC
- Touch screen
- Operation Temperature: 0 ~ 55°C

- Operation Temperature: 0 ~ 55°C
- Prevent high heat dissipation



USCG's final ballast water regulation already came into force back in June 2012, along with IMO's BWM Convention to be enforced sooner, will impose ship owners to install a reliable Ballast Water Treatment System for their vessels with given implementation schedule.

PSRS(pit stop retrofit service) is to provide ship owners with exact, prompt and competitive retrofit service in order to save time and cost. Based on well-proven technology, we also offer ship owners complete retrofit solutions such as project consulting, equipment, engineering, installation as well as supervision and commissioning.



Total Solution for Retrofit

FEATURES



- Comprehensive turn-key proposal
- Highly experienced Engineer with qualified technical skills
- Time, cost saving
- On board Survey & 3D laser scanning for the accurate work
- Certification and Class

SERVICE SCOPE

| | | | | |
|----------|---------------------|-------------|-------------------------------|-------------------|
| CASE I | BWTS Equipment only | | | |
| CASE II | BWTS Equipment | Engineering | | |
| CASE III | BWTS Equipment | Engineering | Supply Installation Materials | |
| CASE IV | BWTS Equipment | Engineering | Supply Installation Materials | Installation Work |

WORKING PLAN

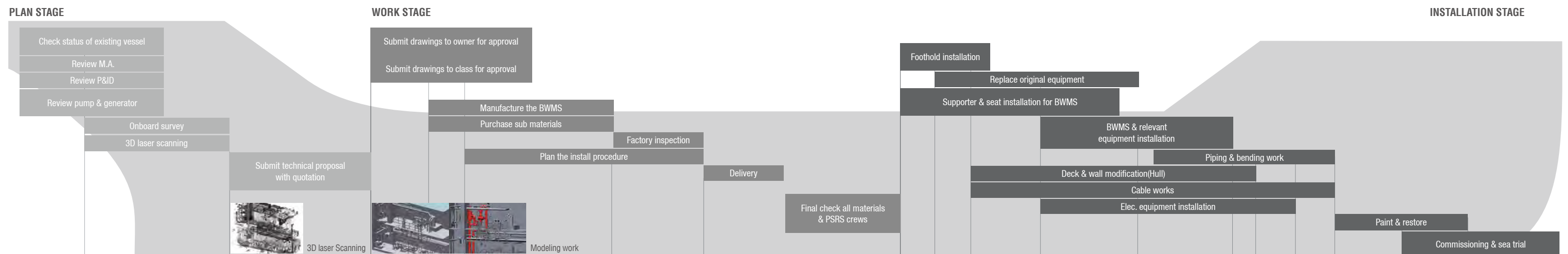

RETROFITTING SCHEDULE

In Drydock or Quay *Asian Naga Project* _____ 7 Days



| | |
|-----------------------|---------------------------|
| Ship's Type | 10K Bulk Carrier |
| Capacity | 150m³/hr |
| Model | GloEn-Patrol™ 150 x 1 set |
| Installation Location | Engine room |
| Retrofit method | Drydock(Sanwa Dock Japan) |

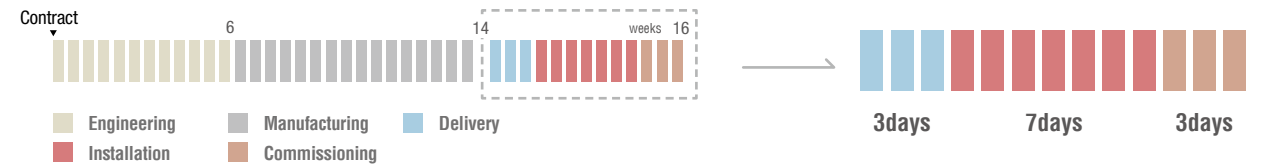

On Voyage *MV Floriana Project* _____ 2 Weeks



| | |
|-----------------------|---------------------------|
| Ship's Type | 34K Bulk Carrier |
| Capacity | 700m³/hr |
| Model | GloEn-Patrol™ 700 x 1 set |
| Installation Location | Engine room |
| Retrofit method | On Voyage(Europe) |

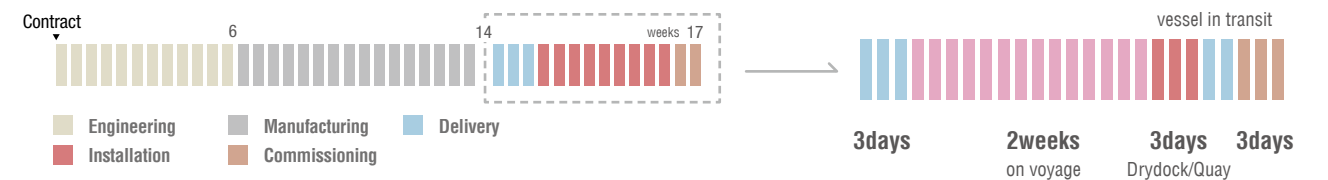

Installation

GloEn-Patrol™ is the answer to all your requirements.

TANKER



| | | | |
|-------------|---------------------|-----------------------|-----------|
| Ship's Type | 320K VLCC | Installation Location | Pump Room |
| Shipyard | Korea | Class | NK |
| Shipowner | Kuwait | Explosion Proof Type | |
| Capacity | 3,000 X 2 / 500 X 1 | | |



| | | | |
|-------------|-------------------|-----------------------|---------|
| Ship's Type | 50.3K PC | Installation Location | On Deck |
| Shipyard | Korea | Class | DNV |
| Shipowner | Italy | Explosion Proof Type | |
| Capacity | 750 X 2 / 300 X 1 | | |

LNG



| | | | |
|-------------|--------------|-----------------------|-------------|
| Ship's Type | 170K CBM LNG | Installation Location | Engine Room |
| Shipyard | Korea | Class | LR / RSMS |
| Shipowner | Russia | | |
| Capacity | 3,000 X 2 | | |

LPG



| | | | |
|-------------|---------|-----------------------|-------------|
| Ship's Type | 38K LPG | Installation Location | Engine Room |
| Shipyard | Korea | Class | ABS |
| Shipowner | Turkey | | |
| Capacity | 500 X 2 | | |

BULK CARRIER



| | | | |
|-------------|------------------|-----------------------|-------------|
| Ship's Type | 82K Bulk Carrier | Installation Location | Engine Room |
| Shipyard | Korea | Class | LR |
| Shipowner | Greece | | |
| Capacity | 1,500 X 2 | | |



| | | | |
|-------------|------------------|-----------------------|-------------|
| Ship's Type | 75K Bulk Carrier | Installation Location | Engine Room |
| Shipyard | Korea | Class | ABS |
| Shipowner | Russia | | |
| Capacity | 1,200 X 2 | | |



| | | | |
|-------------|------------------|-----------------------|-------------|
| Ship's Type | 93K Bulk Carrier | Installation Location | Engine Room |
| Shipyard | Taiwan | Class | BV / CR |
| Shipowner | Taiwan | | |
| Capacity | 1,000 X 2 | | |



| | | | |
|-------------|------------------|-----------------------|-------------|
| Ship's Type | 37K Bulk Carrier | Installation Location | Engine Room |
| Shipyard | Japan | Class | NK |
| Shipowner | Japan | | |
| Capacity | 700 X 2 | | |

Installation

GloEn-Patrol™ is the answer to all your requirements.

CONTAINER



| | | | |
|-------------|----------------------|-----------------------|-------------|
| Ship's Type | 14,500 TEU Container | Installation Location | Engine Room |
| Shipyard | Korea | Class | DNV |
| Shipowner | U.A.E | | |
| Capacity | 1,000 X 2 | | |



| | | | |
|-------------|---------------------|-----------------------|-------------|
| Ship's Type | 9,400 TEU Container | Installation Location | Engine Room |
| Shipyard | China | Class | GL |
| Shipowner | Switzerland | | |
| Capacity | 1,000 X 1 | | |

GENERAL CARGO SHIP



| | | | |
|-------------|---------------------|-----------------------|-------------|
| Ship's Type | 16.5K General Cargo | Installation Location | Engine Room |
| Shipyard | Japan | Class | NK |
| Shipowner | Ireland | | |
| Capacity | 500 X 2 | | |



| | | | |
|-------------|-------------------|-----------------------|-------------|
| Ship's Type | 11K General Cargo | Installation Location | Engine Room |
| Shipyard | Japan | Class | NK |
| Shipowner | Japan | | |
| Capacity | 700 X 2 | | |

Worldwide Service Network

Effective Follow-up Service, Prompt Action for Spare Parts.

